

1. KN35增量光电编码器(空心轴)

1.1 简介:

本产品是一款超薄多种轴型编码器, 结构紧凑、小型化, 普遍用于伺服电机、工业自动化领域。

1.2 特点:

- 编码器直径 $\phi 35\text{mm}$ 、厚度为18mm、轴孔径最大 $\phi 8\text{mm}$;
- 采用非接触式光电原理;
- 极性反接保护;
- 短路保护;
- 多种电气接口可选;
- 分辨率每周最高可达 32768PPR.

1.3 应用范围:

伺服电机、电梯、数控等自动化控制领域

1.4 连接:

- 径向电缆(长0.5M)

1.5 防护等级:

IP40

1.6 重量:

约80g

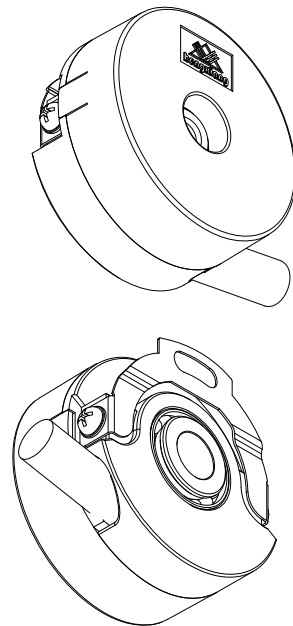

2. 选型指南

2.1 型号构成(选择参数)

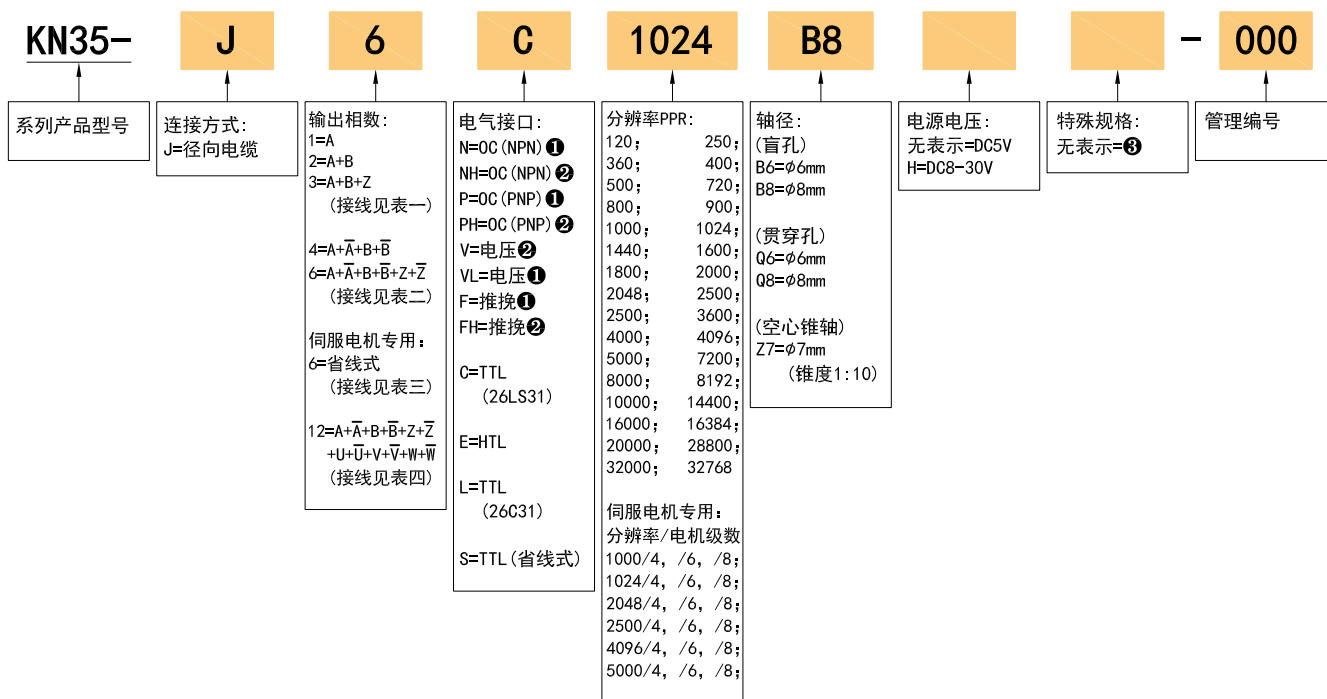

2.2 注解

- ① Z相信号为低电平有效。
- ② Z相信号为高电平有效。
- ③ 无表示为IP40, 电缆线长度0.5M, 如需改变长度C+数字, 最长100M(用C100表示), 具体使用长度请参考第2页输出回路的规定。

3. 输出方式

3.1 增量信号

电气接口	输出回路	输出波形
OC (NPN集电极开路)		<p>a. b. c. d = $\frac{I}{4} \pm \frac{I}{8}$</p> <p>A相比B相进$\frac{I}{4} \pm \frac{I}{8}$相位, 从编码器轴端看顺时针旋转 (参见尺寸图)</p> <p>CW方向 →</p> <p>Z信号为低电平有效</p>
OC (PNP集电极开路)		
推挽		<p>a. b. c. d = $\frac{I}{4} \pm \frac{I}{8}$</p> <p>A相比B相进$\frac{I}{4} \pm \frac{I}{8}$相位, 从编码器轴端看顺时针旋转 (参见尺寸图)</p> <p>CW方向 →</p> <p>Z信号为高电平有效</p>
电压		
TTL (DC5V) HTL (DC8-30V)		<p>a. b. c. d = $\frac{I}{4} \pm \frac{I}{8}$</p> <p>A相比B相进$\frac{I}{4} \pm \frac{I}{8}$相位, 从编码器轴端看顺时针旋转 (参见尺寸图)</p> <p>CW方向 →</p>

3.2 伺服电机专用 (带U、V、W)

电气接口	输出回路	输出波形																																																																	
TTL (DC5V)																																																																			
TTL (DC5V) (省线式)	<div style="display: flex; justify-content: space-between;"> <div style="width: 45%;"> <p>26LS31, 26C31 传输距离 200m Max</p> <p>符号含义 ★: 指定UVW信道的位置 ☆: ABZ信道开始计算的位置 □: 不使用区域 HZ: 高阻抗</p> </div> <div style="width: 45%;"> <table border="1" style="width: 100%; border-collapse: collapse;"> <thead> <tr> <th rowspan="2">序号</th> <th rowspan="2">功能 线色</th> <th colspan="3">模式</th> </tr> <tr> <th>1</th> <th>2</th> <th>3</th> </tr> </thead> <tbody> <tr> <td>3</td> <td>白</td> <td>HZ</td> <td>U</td> <td>A</td> </tr> <tr> <td>4</td> <td>白/黑</td> <td>HZ</td> <td>\bar{U}</td> <td>\bar{A}</td> </tr> <tr> <td>5</td> <td>绿</td> <td>HZ</td> <td>V</td> <td>B</td> </tr> <tr> <td>6</td> <td>绿/黑</td> <td>HZ</td> <td>\bar{V}</td> <td>\bar{B}</td> </tr> <tr> <td>7</td> <td>黄</td> <td>HZ</td> <td>W</td> <td>Z</td> </tr> <tr> <td>8</td> <td>黄/黑</td> <td>HZ</td> <td>\bar{W}</td> <td>\bar{Z}</td> </tr> <tr> <td>1</td> <td>红</td> <td colspan="3">DC+5V</td> </tr> <tr> <td>2</td> <td>黑</td> <td colspan="3">0V</td> </tr> <tr> <td>0</td> <td>屏蔽</td> <td colspan="3">GND</td> </tr> </tbody> </table> </div> </div>	序号	功能 线色	模式			1	2	3	3	白	HZ	U	A	4	白/黑	HZ	\bar{U}	\bar{A}	5	绿	HZ	V	B	6	绿/黑	HZ	\bar{V}	\bar{B}	7	黄	HZ	W	Z	8	黄/黑	HZ	\bar{W}	\bar{Z}	1	红	DC+5V			2	黑	0V			0	屏蔽	GND			<table border="1" style="width: 100%; border-collapse: collapse;"> <thead> <tr> <th>极数</th> <th>g. h. j. k. m. n</th> <th>r</th> </tr> </thead> <tbody> <tr> <td>4</td> <td>$30 \pm 1^\circ$</td> <td>180°</td> </tr> <tr> <td>6</td> <td>$20 \pm 1^\circ$</td> <td>120°</td> </tr> <tr> <td>8</td> <td>$15 \pm 1^\circ$</td> <td>90°</td> </tr> </tbody> </table> <p>a. b. c. d = $\frac{1}{2} \pm \frac{1}{8}$ e = $T \pm \frac{1}{2}$ f: Z相中心至U相上升缘 $\pm 1^\circ$</p> <p>CCW方向 \longrightarrow 从轴端看逆时针旋转 (参见尺寸图)</p>	极数	g. h. j. k. m. n	r	4	$30 \pm 1^\circ$	180°	6	$20 \pm 1^\circ$	120°	8	$15 \pm 1^\circ$	90°
序号	功能 线色			模式																																																															
		1	2	3																																																															
3	白	HZ	U	A																																																															
4	白/黑	HZ	\bar{U}	\bar{A}																																																															
5	绿	HZ	V	B																																																															
6	绿/黑	HZ	\bar{V}	\bar{B}																																																															
7	黄	HZ	W	Z																																																															
8	黄/黑	HZ	\bar{W}	\bar{Z}																																																															
1	红	DC+5V																																																																	
2	黑	0V																																																																	
0	屏蔽	GND																																																																	
极数	g. h. j. k. m. n	r																																																																	
4	$30 \pm 1^\circ$	180°																																																																	
6	$20 \pm 1^\circ$	120°																																																																	
8	$15 \pm 1^\circ$	90°																																																																	
<p>模式时间图</p>																																																																			

4. 电气参数

参数 项目	输出类型		OC	电压	推挽	TTL	TTL (省线式)	HTL
	输出	类型						
电源电压	DC+5V±5%; DC8V-30V±5%					DC+5V±5%		DC8-30V±5%
消耗电流	100mA Max					120mA Max		
容许波纹	≤3%rms							
最高响应频率	100KHz					300KHz		500KHz
输出 容量	输出 电流	流入	≤30mA	负载电阻2.2K	≤30mA	≤±20mA		≤±50mA
		流出	—		≤10mA			
	输出 电压	“H”	—	—	≥[(电源电压)-2.5V]	≥2.5V		≥V _{cc} -3 V _{dc}
		“L”	≤0.4V	≤0.7V (20mA以下)	≤0.4V (30mA)	≤0.5V		≤1V V _{dc}
负载电压	≤DC30V		—	—		—		
上升, 下降时间	2us以下(导线长: 2m)					1us以下(导线长: 2m)		≤100ns
绝缘耐压	AC500V 60s							
绝缘阻抗	10MΩ							
占空比	45% to 55%							
极性反接保护	✓							
短路保护	—					✓①		
A. B相位差	90° ±10° (低速频率下)							
	90° ±20° (高速频率下)							
延时动作时间②	—					510±220ms		—
屏蔽线	未接编码器本体							

① 与另一个线缆短路或GND, 最大允许时间30秒。

② 通电时 A. B. Z 迟后 U. V. W 时间。

5. 机械规格

轴 径	φ6mm; φ8mm; φ7mm锥轴(可选)
起动转矩	$5.9 \times 10^{-3} \text{ N} \cdot \text{m}$ 以下
惯性力矩	$1.5 \times 10^{-6} \text{ kg} \cdot \text{m}^2$ 以下
轴允许力	径向30N; 轴向20N
允许最高转速	≤5000 rpm
轴承寿命	额定负载 1.5×10^9 , 2500RPM时100000小时
外 壳	铝合金
重 量	约80g

6. 环境参数



环境温度	工作时: $-20 \sim +85^{\circ}\text{C}$ (反复弯曲电缆: -10°C); 保存时: $-20 \sim +90^{\circ}\text{C}$
环境湿度	工作时, 保存时: 各35~85%RH (不结露)
振动(耐久)	振幅0.75mm, 5~55HZ, 三轴方向各2h
冲击(耐久)	490m/s^2 11ms X, Y, Z各方向3次
防护等级	IP40

7. 接线表

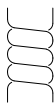
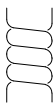

7.1 0C/电压/推挽 (表一)

线色	供电电压		增量信号		
	红	黑	白	绿	黄
功能	Up	0V	A	B	Z

7.2 TTL/HTL (表二)



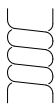
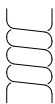



线色	供电电压		增量信号					
	红	黑	白	白/黑	绿	绿/黑	黄	黄/黑
功能	Up	0V	A+	A-	B+	B-	Z+	Z-
双绞线								

7.3 省线式 (表三)

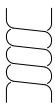
线色	供电电压		增量信号					
	红	黑	白	白/黑	绿	绿/黑	黄	黄/黑
功能	Up	0V	A+ (U+)*	A- (U-)*	B+ (V+)*	B- (V-)*	Z+ (W+)*	Z- (W-)*
双绞线								

* 在省线式模式下的功能状态, 对照第3页输出回路的功能模式接线表。

7.4 伺服电机专用 (表四)

线色	供电电压		增量信号											
	红	黑	白	白/黑	绿	绿/黑	黄	黄/黑	蓝	蓝/黑	灰	灰/黑	粉	粉/黑
功能	Up	0V	A+	A-	B+	B-	Z+	Z-	U+	U-	V+	V-	W+	W-
双绞线														

Up=电源电压。

屏蔽线未接编码器内部电路。

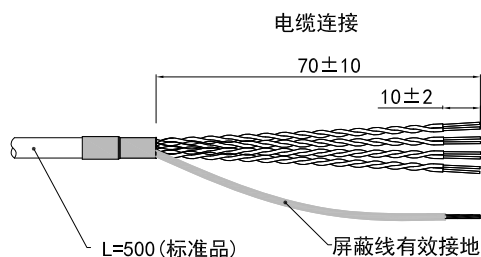

8. 基本尺寸

8.1 Z(空心锥轴)

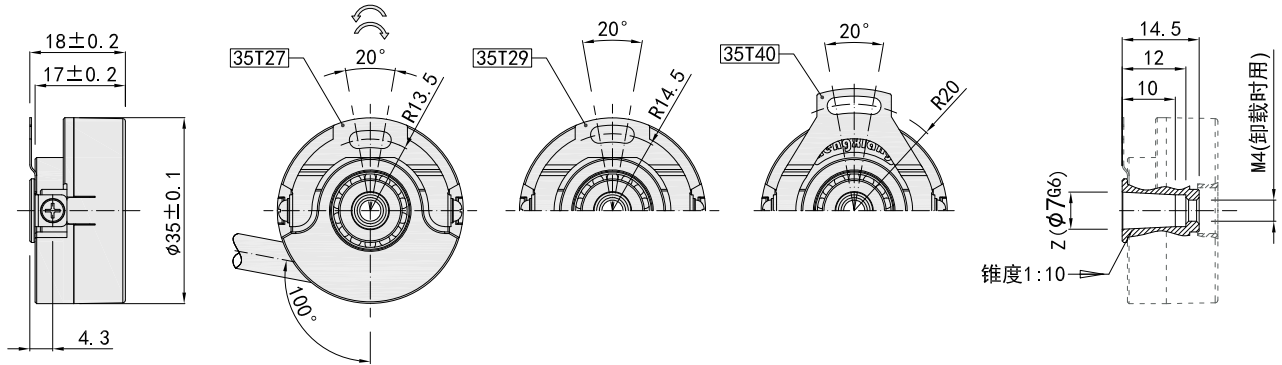

8.2 B(盲孔轴)

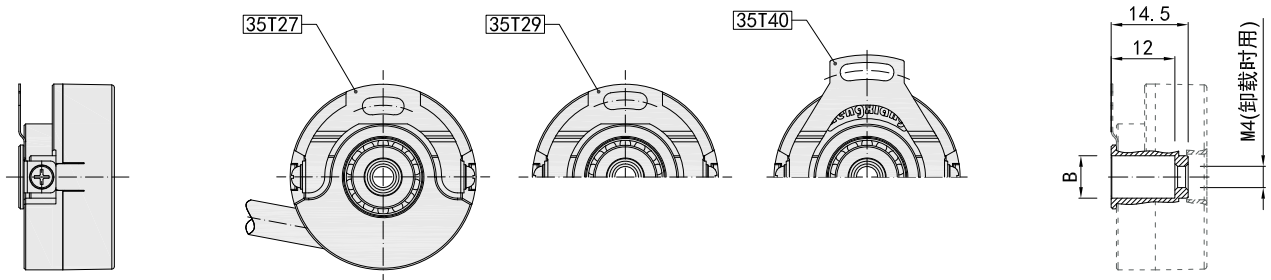

8.3 Q(贯穿轴)

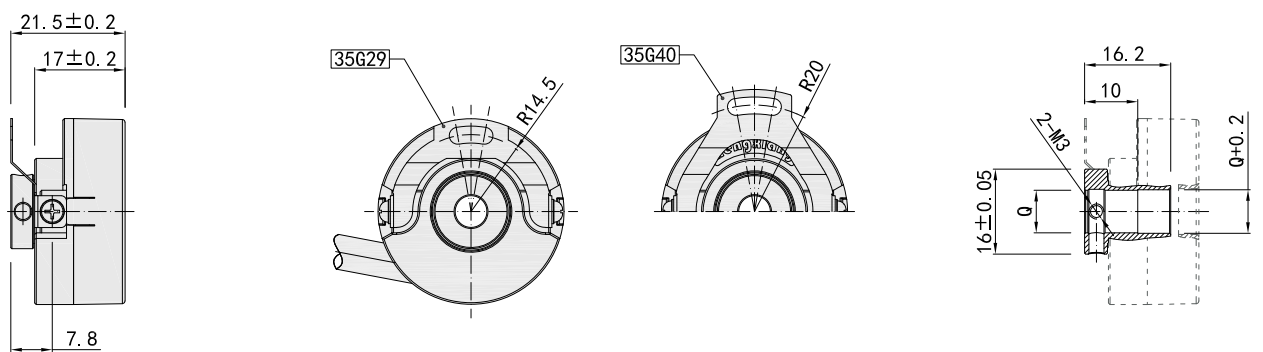

单位: mm

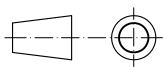

= 增量信号输出的轴旋转方向

= 伺服电机专用信号输出的轴旋转方向

35T27 35T29 35T40 35G29 35G40 = 安装弹簧板(请参阅本规格书第9页)

关于震动

加在旋转编码器上的振动, 往往会成为脉冲误发生的原因, 因此应该对设置场所加以注意。每转脉冲数越多, 光栅的槽孔间隔越窄, 越易受到振动的影响, 在低速旋转或停止时, 加在轴或本体上的振动使光栅抖动, 可能会发生误脉冲。

9. 安装轴要求

9.1 Z(空心锥轴)

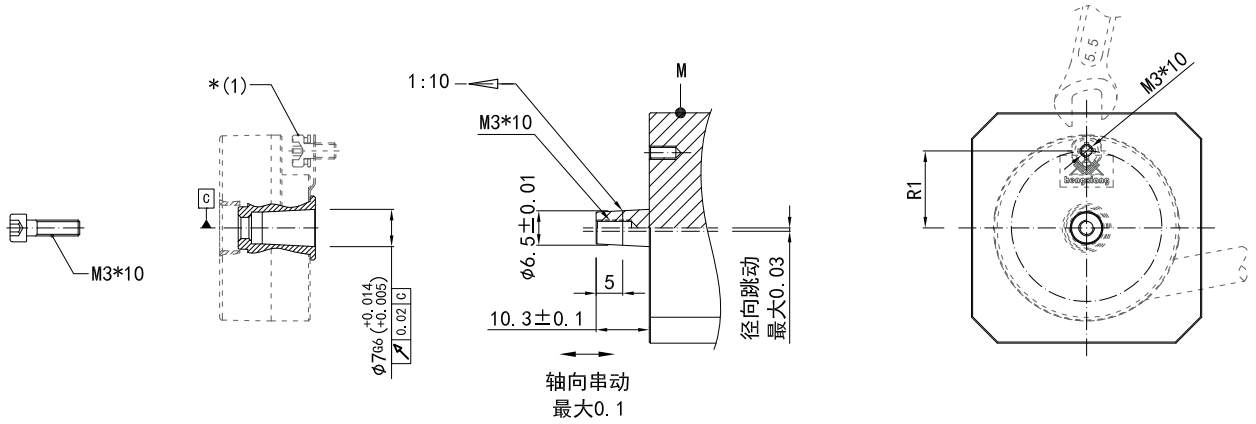

9.2 B(盲孔轴)

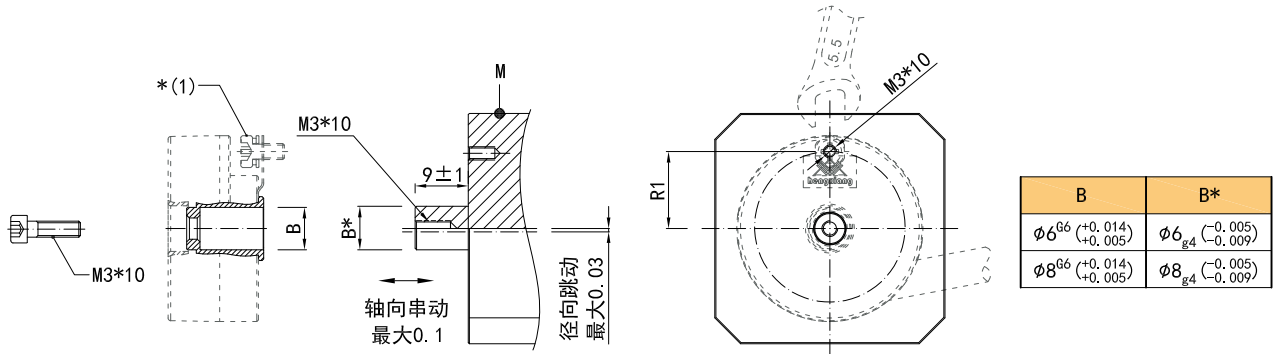

9.3 Q(贯穿轴)

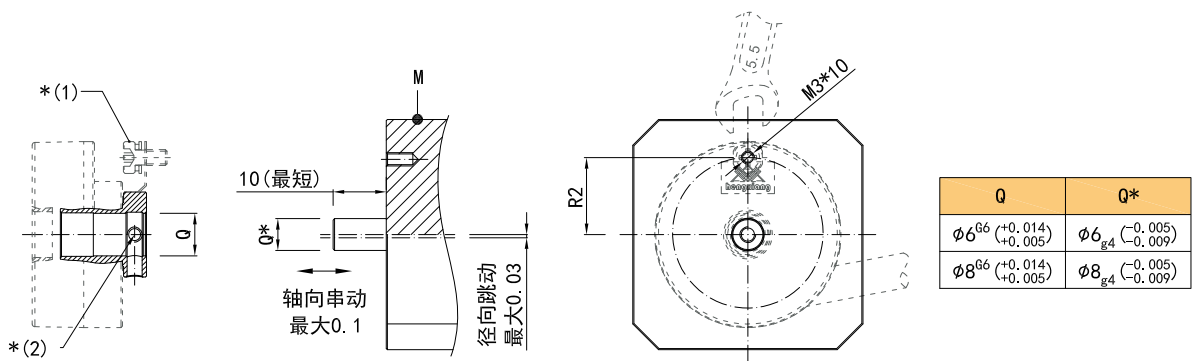

单位: mm

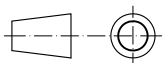

M=电机

备注:









* (1): 推荐用外六角螺丝M3*10加平垫片和弹簧圈使用

* (2): 两个M3*3顶丝涂上螺纹胶并拧紧, 建议拧紧力为0.6 N.m.

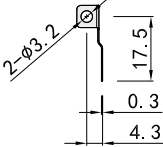
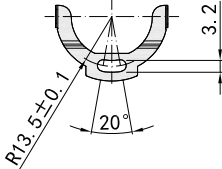
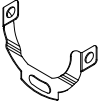
R1: $R13.5 \pm 0.1$ & $R14.5 \pm 0.1$ & $R20 \pm 0.1$ (以选择弹簧板确定安装尺寸)

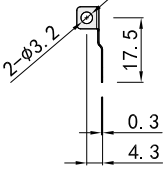
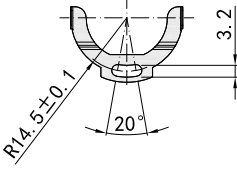
R2: $R14.5 \pm 0.1$ & $R20 \pm 0.1$ (以选择弹簧板确定安装尺寸)

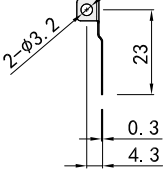
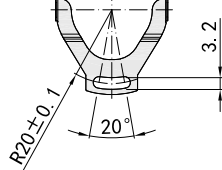
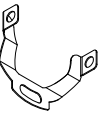
10. 附件 (安装弹簧板选配)

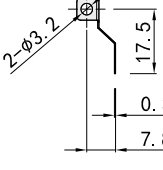
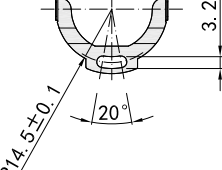
<p>35T27 No: 03700116</p> 			
<p>35T29 No: 03700117</p> 			
<p>35T40 No: 03700118</p> 			
<p>35G29 No: 03700119</p> 			
<p>35G40 No: 03700120</p> 