

# K58

## ■ 增量式(空心轴、贯穿)

- 特点: 薄型, 坚固耐用, 多种输出方式可选, 安装方便
- 应用范围: 纺织行业、电机、包装机械、工业流水线等工业自动化控制
- 外形尺寸: 外径 $\phi 58\text{mm}$ , 厚度为 $24\text{mm}$ , 轴径有 $\phi 15\text{mm}$ ;  $\phi 16\text{mm}$ ;  $\phi 18\text{mm}$ ;  $\phi 20\text{mm}$ ;  $\phi 22\text{mm}$ (可选)
- 分辨率: 可达 $28800\text{P/R}$
- 电源电压:  $\text{DC}5\text{V}$ ;  $\text{DC}8\text{--}30\text{V}$
- 防护等级:  $\text{IP}50$
- 线长:  $1000\text{mm}$
- 重量: 约 $150\text{g}$

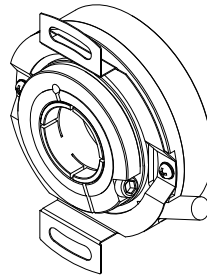

K58-J  
(轴前抱紧)

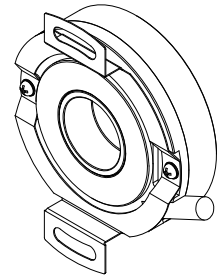

K58-J  
(轴后抱紧)

## ■ 选型指南

- 型号构成(在方格中填上所需的参数)
- 需选择供电电压:  $\text{DC}5\text{V}$ ;  $\text{DC}8\text{--}30\text{V}$
- 在选择轴径的同时必须选择轴前抱紧(BQ)或轴后抱紧(B)
- 安装弹簧板(请参阅6/6页附件)

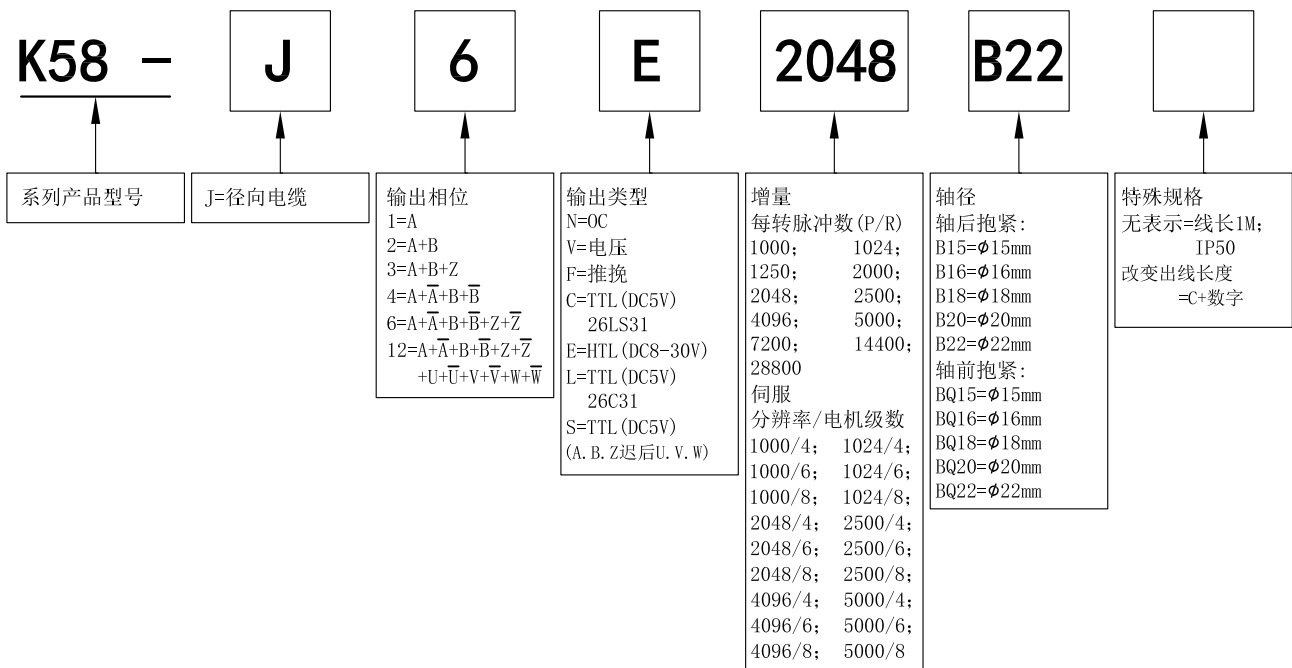

■ 输出方式

输出类型	输出回路	输出波形	连接
OC		<p>A相 B相 Z相</p> <p><math>T(360^\circ)</math> a b c d</p> <p>a. b. c. d = <math>\frac{T}{4} \pm 8\%</math></p> <p>A相比B相进<math>\frac{T}{4} \pm 8\%</math>相位, 旋转方向CW (从轴端看顺时针旋转)</p> <p>CW方向 →</p>	<p>0=GND 1=红=DC5V; DC8-30V 2=黑=0V 3=白=A 4=绿=B 5=黄=Z</p>
推挽		<p>A相 B相 Z相</p> <p><math>T(360^\circ)</math> a b c d</p> <p>a. b. c. d = <math>\frac{T}{4} \pm 8\%</math></p> <p>A相比B相进<math>\frac{T}{4} \pm 8\%</math>相位, 旋转方向CW (从轴端看顺时针旋转)</p> <p>CW方向 →</p>	
电压		<p>A相 B相 Z相</p> <p><math>T(360^\circ)</math> a b c d</p> <p>a. b. c. d = <math>\frac{T}{4} \pm 8\%</math></p> <p>A相比B相进<math>\frac{T}{4} \pm 8\%</math>相位, 旋转方向CW (从轴端看顺时针旋转)</p> <p>CW方向 →</p>	
TTL HTL		<p>A相 A相 B相 B相 Z相 Z相</p> <p><math>T(360^\circ)</math> a b c d</p> <p>a. b. c. d = <math>\frac{T}{4} \pm 8\%</math></p> <p>A相比B相进<math>\frac{T}{4} \pm 8\%</math>相位, 旋转方向CW (从轴端看顺时针旋转)</p> <p>CW方向 →</p>	

● 输出方式

输出类型	输出回路	输出波形	连接																																																																	
TTL		<p>a. b. c. d = <math>\frac{T}{4} \pm \frac{1}{8}</math> e = <math>\frac{T}{2} \pm \frac{1}{2}</math> f: Z相中心至U相上升缘 <math>\pm 0.3^\circ</math></p> <p>CCW方向 → (从轴端看逆时针旋转)</p> <p>A. B. Z. U. V. W <math>\bar{A}. \bar{B}. \bar{Z}. \bar{U}. \bar{V}. \bar{W}</math></p>	<p>0=屏蔽=GND 1=红=DC5V 2=黑=0V 3=白=A 4=绿=B 5=黄=Z 6=白/黑=<math>\bar{A}</math> 7=绿/黑=<math>\bar{B}</math> 8=黄/黑=<math>\bar{Z}</math> 9=蓝=U 10=灰=V 11=粉红=W 12=蓝/黑=<math>\bar{U}</math> 13=灰/黑=<math>\bar{V}</math> 14=粉红/黑=<math>\bar{W}</math></p>																																																																	
TTL (A. B. Z滞后 U. V. W)	<table border="1" data-bbox="395 1189 608 1294"> <thead> <tr> <th>极数</th> <th>g. h. j. k. m. n</th> <th>r</th> </tr> </thead> <tbody> <tr> <td>4</td> <td><math>30 \pm 1^\circ</math></td> <td><math>180^\circ</math></td> </tr> <tr> <td>6</td> <td><math>20 \pm 1^\circ</math></td> <td><math>120^\circ</math></td> </tr> <tr> <td>8</td> <td><math>15 \pm 1^\circ</math></td> <td><math>90^\circ</math></td> </tr> </tbody> </table>	极数	g. h. j. k. m. n	r	4	$30 \pm 1^\circ$	$180^\circ$	6	$20 \pm 1^\circ$	$120^\circ$	8	$15 \pm 1^\circ$	$90^\circ$	<p>a. b. c. d = <math>\frac{T}{4} \pm \frac{1}{8}</math> e = <math>\frac{T}{2} \pm \frac{1}{2}</math> f: Z相中心至U相上升缘 <math>\pm 0.3^\circ</math></p> <p>CCW方向 → (从轴端看逆时针旋转)</p> <p>A. B. Z. U. V. W <math>\bar{A}. \bar{B}. \bar{Z}. \bar{U}. \bar{V}. \bar{W}</math></p>	<table border="1" data-bbox="1166 891 1449 1361"> <thead> <tr> <th rowspan="2">序号</th> <th rowspan="2">功能 线色</th> <th colspan="3">模式</th> </tr> <tr> <th>1</th> <th>2</th> <th>3</th> </tr> </thead> <tbody> <tr> <td>3</td> <td>白</td> <td>HZ</td> <td>U</td> <td>A</td> </tr> <tr> <td>6</td> <td>白/黑</td> <td>HZ</td> <td><math>\bar{U}</math></td> <td><math>\bar{A}</math></td> </tr> <tr> <td>4</td> <td>绿</td> <td>HZ</td> <td>V</td> <td>B</td> </tr> <tr> <td>7</td> <td>绿/黑</td> <td>HZ</td> <td><math>\bar{V}</math></td> <td><math>\bar{B}</math></td> </tr> <tr> <td>5</td> <td>黄</td> <td>HZ</td> <td>W</td> <td>Z</td> </tr> <tr> <td>8</td> <td>黄/黑</td> <td>HZ</td> <td><math>\bar{W}</math></td> <td><math>\bar{Z}</math></td> </tr> <tr> <td>1</td> <td>红</td> <td colspan="3">DC+5V</td> </tr> <tr> <td>2</td> <td>黑</td> <td colspan="3">0V</td> </tr> <tr> <td>0</td> <td>屏蔽</td> <td colspan="3">GND</td> </tr> </tbody> </table>	序号	功能 线色	模式			1	2	3	3	白	HZ	U	A	6	白/黑	HZ	$\bar{U}$	$\bar{A}$	4	绿	HZ	V	B	7	绿/黑	HZ	$\bar{V}$	$\bar{B}$	5	黄	HZ	W	Z	8	黄/黑	HZ	$\bar{W}$	$\bar{Z}$	1	红	DC+5V			2	黑	0V			0	屏蔽	GND		
极数	g. h. j. k. m. n	r																																																																		
4	$30 \pm 1^\circ$	$180^\circ$																																																																		
6	$20 \pm 1^\circ$	$120^\circ$																																																																		
8	$15 \pm 1^\circ$	$90^\circ$																																																																		
序号	功能 线色	模式																																																																		
		1	2	3																																																																
3	白	HZ	U	A																																																																
6	白/黑	HZ	$\bar{U}$	$\bar{A}$																																																																
4	绿	HZ	V	B																																																																
7	绿/黑	HZ	$\bar{V}$	$\bar{B}$																																																																
5	黄	HZ	W	Z																																																																
8	黄/黑	HZ	$\bar{W}$	$\bar{Z}$																																																																
1	红	DC+5V																																																																		
2	黑	0V																																																																		
0	屏蔽	GND																																																																		
<p>模式时间图</p> <p>电源电压</p> <p>5 <math>\pm</math> 0.25 4.25 <math>\pm</math> 0.3</p> <p>电压瞬时下 电源关闭</p> <p>电源打开</p> <p>35MIN 7 <math>\pm</math> 2</p> <p>模式</p> <p>1 2 3</p> <p>1 1 1</p> <p>510 <math>\pm</math> 220 22 <math>\pm</math> 11</p>																																																																				
<p>符号含义</p> <p>★: 指定UVW信道的位置</p> <p>☆: ABZ信道开始计算的位置</p> <p>∅: 不使用区域</p> <p>HZ: 高阻抗</p>																																																																				

## ■ 电气规格

参数 项目	输出类型		OC	电压	推挽	TTL (26LS31)	TTL (26C31)	TTL (A. B. Z迟后U. V. W)	HTL (HD7)
	电源电压			DC+5V ± 5%; DC8V-30V ± 5%			DC+5V ± 5%		
消耗电流			100mA Max			120mA Max			
容许波纹			≤ 3%rms						
最高响应频率			100KHz			200KHz			300KHz
输出容量	输出电流	流入	≤ 30mA	负载电阻2.2K	≤ 30mA	≤ ± 20mA			≤ ± 50mA
		流出	—		≤ 10mA				
	输出电压	“H”	—	—	≥ [(电源电压)-2.5V]	≥ 2.5V			≥ V <sub>CC</sub> -3 V <sub>DC</sub>
		“L”	≤ 0.4V	≤ 0.7V (20mA以下)	≤ 0.4V (30mA)	≤ 0.5V			≤ 1V V <sub>DC</sub>
负载电压			≤ DC30V	—	—				
上升, 下降时间			2us以下(导线长: 2m)			1us以下(导线长: 2m)			≤ 100ns
绝缘耐压			AC500V 60s						
绝缘阻抗			10MΩ						
占空比			45% to 55%						
A. B相位差			90° ± 10° (*低速频率下)						
			90° ± 20° (高速频率下)						
原点动作			低电平有效	高电平有效	低电平有效	—		低电平有效	—
延时动作时间*			—					510 ± 220ms	—
屏蔽线			未接编码器本体						

\* 通电时A. B. Z迟后U. V. W时间。

## ■ 机械规格

轴 径	φ15mm; φ16mm; φ18mm; φ20mm; φ22mm(不锈钢)
起动转矩	$9.8 \times 10^{-3} \text{ N} \cdot \text{m}$ 以下
惯性力矩	$6.5 \times 10^{-6} \text{ kg} \cdot \text{m}^2$ 以下
轴允许力	径向50N; 轴向30N
允许最高转速	≤ 3000 rpm
轴承寿命	额定负载 $1.5 \times 10^9$ , 2500RPM时100000小时
外 壳	压铸铝合金
重 量	约150g

## ■ 环境参数

环境温度	工作时: -20~+85℃(反复弯曲电缆:-10℃); 保存时: -25~+90℃
环境湿度	工作时, 保存时: 各35~85%RH(不结露)
振动(耐久)	振幅1.52mm, 5~55HZ, 三轴方向各2h
冲击(耐久)	980m/s <sup>2</sup> 11ms X, Y, Z各方向3次
防护等级	IP50

# K58

## 基本尺寸

### 轴前抱紧 (BQ)

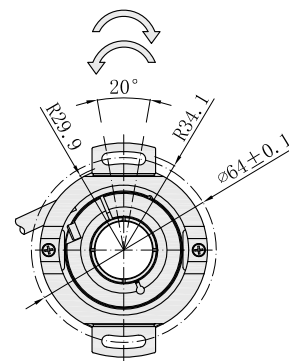
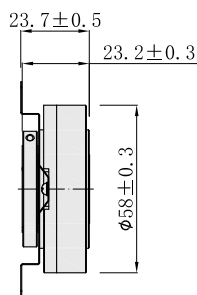
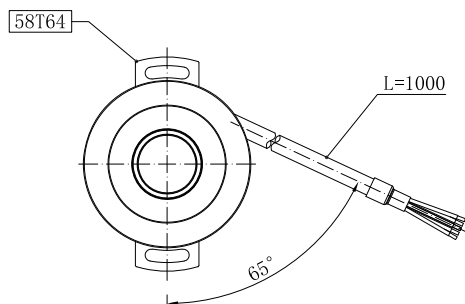

### 轴后抱紧 (B)

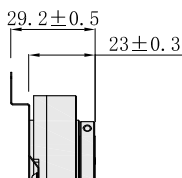

## 装配要求

### 轴前抱紧 (BQ)

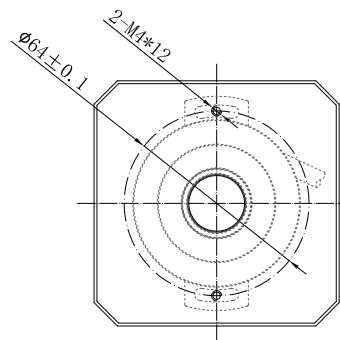
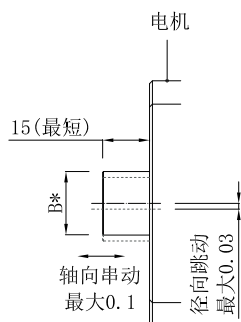
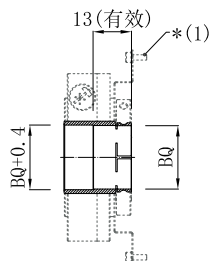

### 轴后抱紧 (B)

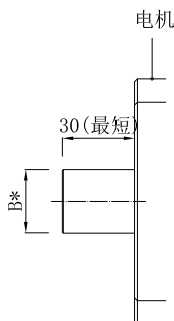
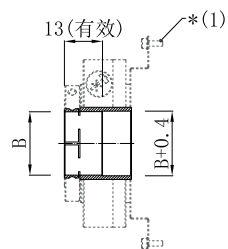

BQ	B	B*
$\phi 15^{G7}_{+0.006/+0.024}$	$\phi 15_{g6}^{-0.006/-0.017}$	$\phi 15_{g6}^{-0.006/-0.017}$
$\phi 16^{G7}_{+0.006/+0.024}$	$\phi 16_{g6}^{-0.006/-0.017}$	$\phi 16_{g6}^{-0.006/-0.017}$
$\phi 18^{G7}_{+0.007/+0.028}$	$\phi 18_{g6}^{-0.006/-0.017}$	$\phi 18_{g6}^{-0.006/-0.017}$
$\phi 20^{G7}_{+0.007/+0.028}$	$\phi 20_{g6}^{-0.007/-0.020}$	$\phi 20_{g6}^{-0.007/-0.020}$
$\phi 22^{G7}_{+0.007/+0.028}$	$\phi 22_{g6}^{-0.007/-0.020}$	$\phi 22_{g6}^{-0.007/-0.020}$

B\* 电机轴径公差

单位: mm

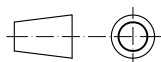

备注:

\* (1): 推荐用内六角螺丝M4\*8加平垫片和弹簧圈使用

58T64 = 弹簧板

= 不带UVW信号输出的轴旋转方向

= 带UVW信号输出的轴旋转方向

■ 附件(弹簧板)

<p>58T64标配</p>	
<p>58T80另购 此弹簧板可以安装在电机后盖拱形表面上</p>	

单位: mm

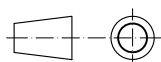

备注:

- \* (2): 轴前抱紧 (BQ)
- \* (3): 轴后抱紧 (B)

关于震动

加在旋转编码器上的震动, 往往会成为脉冲误发生的原因, 因此应该对设置场所加以注意。每转脉冲数越多, 光栅的槽孔间隔越窄, 越易受到震动的影响, 在低速旋转或停止时, 加在轴或本体上的震动使光栅抖动, 可能会发生误脉冲。